

DN8-A

SELPPOWERED COMPACT 2 WAY SYSTEM DSP CONTROLLED

1.- INTRODUCTION

DN-8 enclosure is a selfpowered two way multipurpose cabinet offering high performance and sound levels in a vertical or horizontal shape. Its design and components quality, make DN-8 a perfect system to be used for indoor or outdoor uses as reinforcement of music and speech in entertainment or live applications.

Designed as bass-reflex tuned to optimize low frequency response, system extends frequency bandwidth from 70Hz to 20KHz.

New DN Series, have been specially designed by using new powerful Neodymium magnet structures for both Low and High ways in a Bass-Reflex box design.

DN-8A features a 250W+100W RMS power module controlled with a 96KHz, mixed mode 64 bit digital processing DSP including all necessary Factory presets to optimize DN-8A system in any possible mode including full-range and High-pass filtered when a subwoofer is used.

DN-8A amplifier modules features the latest 3rd generation Class D technology for pro-audio amplification delivering highest dynamic range and the lowest distortion.

The Universal Switch Mode Power Supply includes an automatic AC voltage selection with an operation range from 85V to 268V delivering consistent power world-wide, fully self-protected.

DN-8A features a 96KHz sample rate, 64 bits Input DSP module with high quality A/D D/A converters. Input DSP modules have analogue Input/Link XLRs connector as well as Input/Outputs signals Remote Control and Monitoring through Ethernet interface in a Star Network configuration.

Two push-button are available in DN-8A rear panel: one of them to select between 5 factory presets with all X-Over, optimization filters and precise time alignments depending on DN-8A configuration and second one to switch between full-range and high-passed when subwoofer cabinets are used together DN-8A.

There are 75 empty factory presets available via PC software in which user may save its own optimization filters. DN Series is equipped with last MUSICSON Neodymium magnet structure transducers delivering higher SPL levels with less enclosure weight.

- 8" Low frequency speaker, has been assembled with a 2" (52mm) voice coil in a powerful neodymium structure.
- High Frequency driver consist on a powerful 4" Neodymium magnet with a 1.75" polymer diaphragm to increase very high frequency response with much less distortion than metallic (titanium, aluminum) ones but increasing lifespan due to a higher resistance to mechanical fatigue.

DN Series is equipped also with a 90° rotatable high frequency horn to deliver same parameters either in horizontal or vertical enclosure assembling.



CABINET SPECIFICATIONS

Frequency Response	70Hz – 19.5KHz (-6 dB) 66Hz – 20KHz (-10 dB)
Coverage	70° x 40° Rotatable horn
Components	LF: 1 x 8" . 2" (52mm) Voice coil. HF: 1 x 1.75" Polymer Diaphragm.
Power	LF: 1 x 300W RMS / 1 x 900W Peak HF: 1 x 80W RMS / 1 x 320W Peak
Sensitivity	LF: 97 dB (1W/1m) / 126 dB Peak HF: 107dB (1W/1m) / 132dB Peak
X-Over Freq.	1700 Hz
Weight	23.7Kg
Dimensions	(H x W x D):530x315x305 mm
Construction	12mm Marine plywood
Finishing	Black Bi-component Polyurea based painting
Rigging System	5xM6 nuts on top and 4xM6 on bottom

POWER MODULE

Amplification	350W Continuous (250W+100W) Class D
Input Impedance	10KOhm Balanced Signal
S/N Ratio	>120dBA (A-weighted)
Input Level	2,22 dBu / 1 Vrms (Gain selectable)
Slew Rate	30V/us (8OHM)
Damping Factor	20Hz – 200Hz: 1000
Protection circuits	Input Limiter, Shortcircuit, Output DC, Module Temperature,
Mains Voltage	Selectable 125V or 220VAC 50/60Hz

DSP MODULE

DSP Processing	96KHz, 64 bit DSP
Latency	600 µs
Signal Connectors	XLR Female/XLR Male (Link)
Nominal Input Lev.	+6dBu
Max. Input Level	+21dBu
Network Connector	Ethercon RJ/45, Cat-5
Network	10/100Mb Ethernet
Remote Control	Via rear panel pushbutton and PC (User PC and MAC software included)
Remote Control Parameters	Input Gain, Mute, Input Delay Input Limiter, Input/Outputs Signal Monitoring, Advanced Grouping functions
Dynamic Range	114dB (Inputs) / 114dB (Outputs)

4.- FREQUENCY RESPONSE

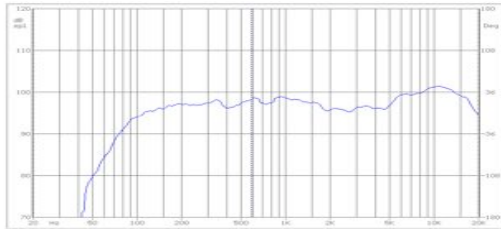

DN-10A Frequency Response (1w/1m)

Frequency Response with active filters and optimization filters.
Response obtained placing Mic. in cabinet acoustic center
Anechoic conditions

5.- MEASURES

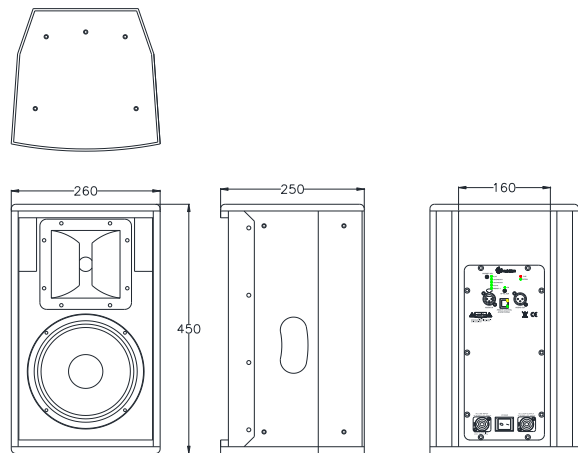

6.- HORIZONTAL POLAR PLOTS

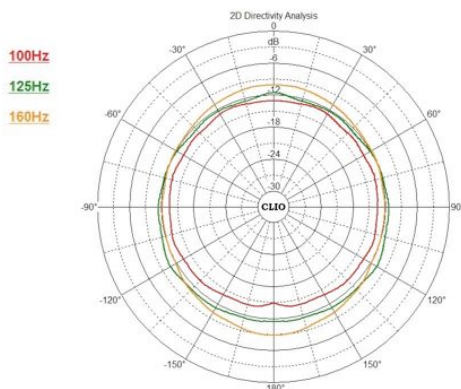

Polar plots from 100Hz to 160Hz. 6dB/

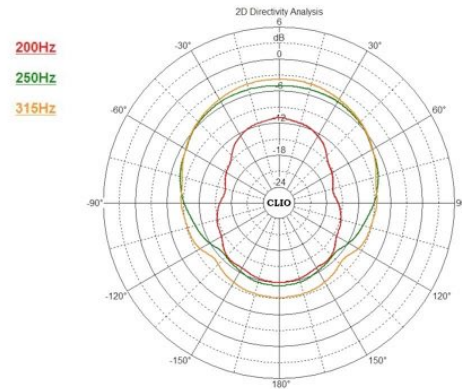

Polar plots from 200Hz to 315Hz. 6dB/div

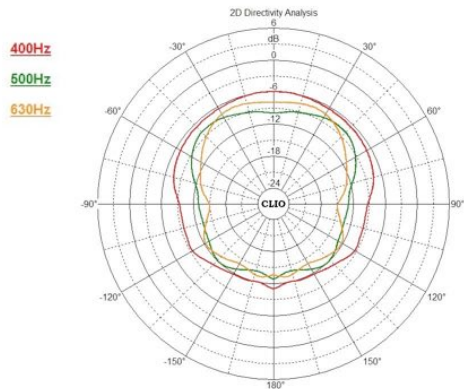

Polar plots from 400Hz to 630Hz. 6dB/div

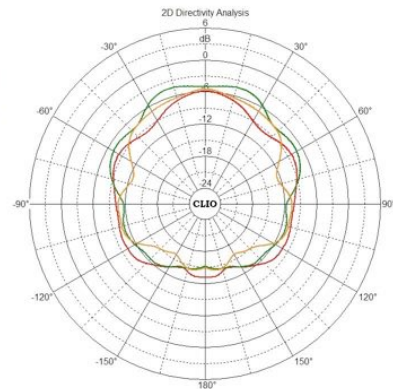

Polar plots from 800Hz to 1250Hz. 6dB/div

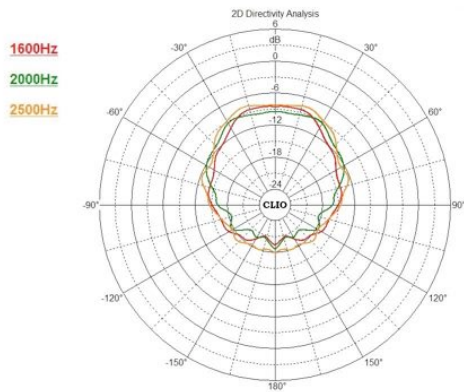

Polar plots from 1600Hz to 2.5KHz. 6dB/div

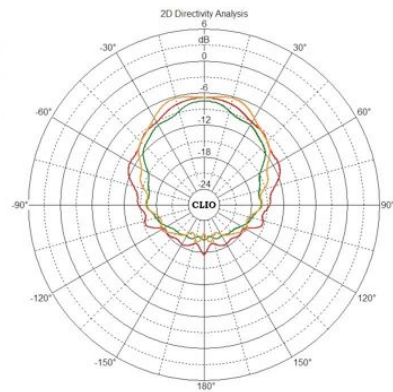

Polar plots from 3150Hz to 5KHz. 6dB/div

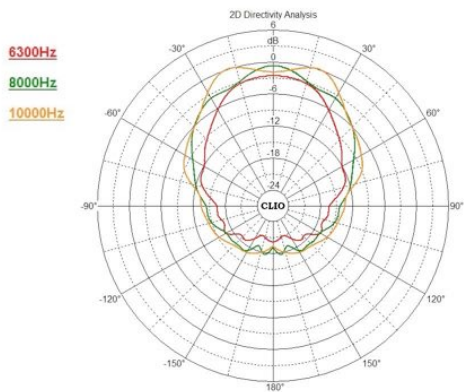

Polar plots from 6300Hz to 10KHz. 6dB/div

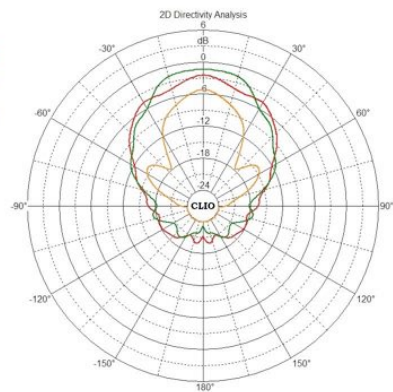

Polar plots from 12600Hz to 20KHz. 6dB/div

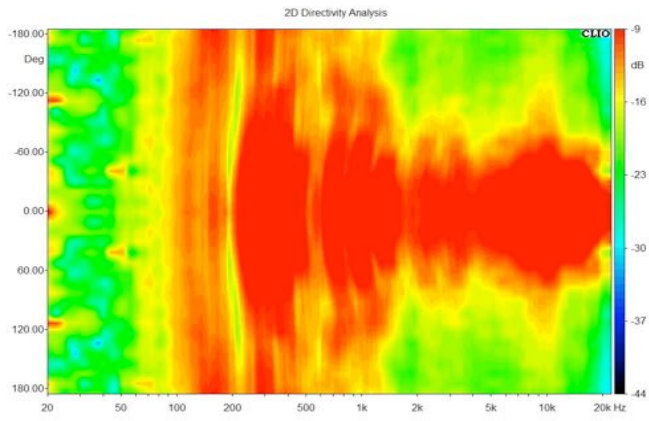

MUSICSON S.L
C/Dr. Mora Sanz S/N
46920. Mislata
Valencia (Spain)
www.musicson.com
musicson@musicson.com